



# Cuaderno de actividades

## LECTOESCRITURA



.....

Letra A

.....

# Cuadernos y recursos gratis

Gracias por descargar este cuaderno de [edufichas.com](http://edufichas.com).  
En nuestra web encontrarás más recursos para imprimir  
y cuadernos como este.

Este cuaderno es gratuito. Prohibida su venta.



Nombre: ..... Fecha: ..... Curso: .....

# Letra A



edufichas.com

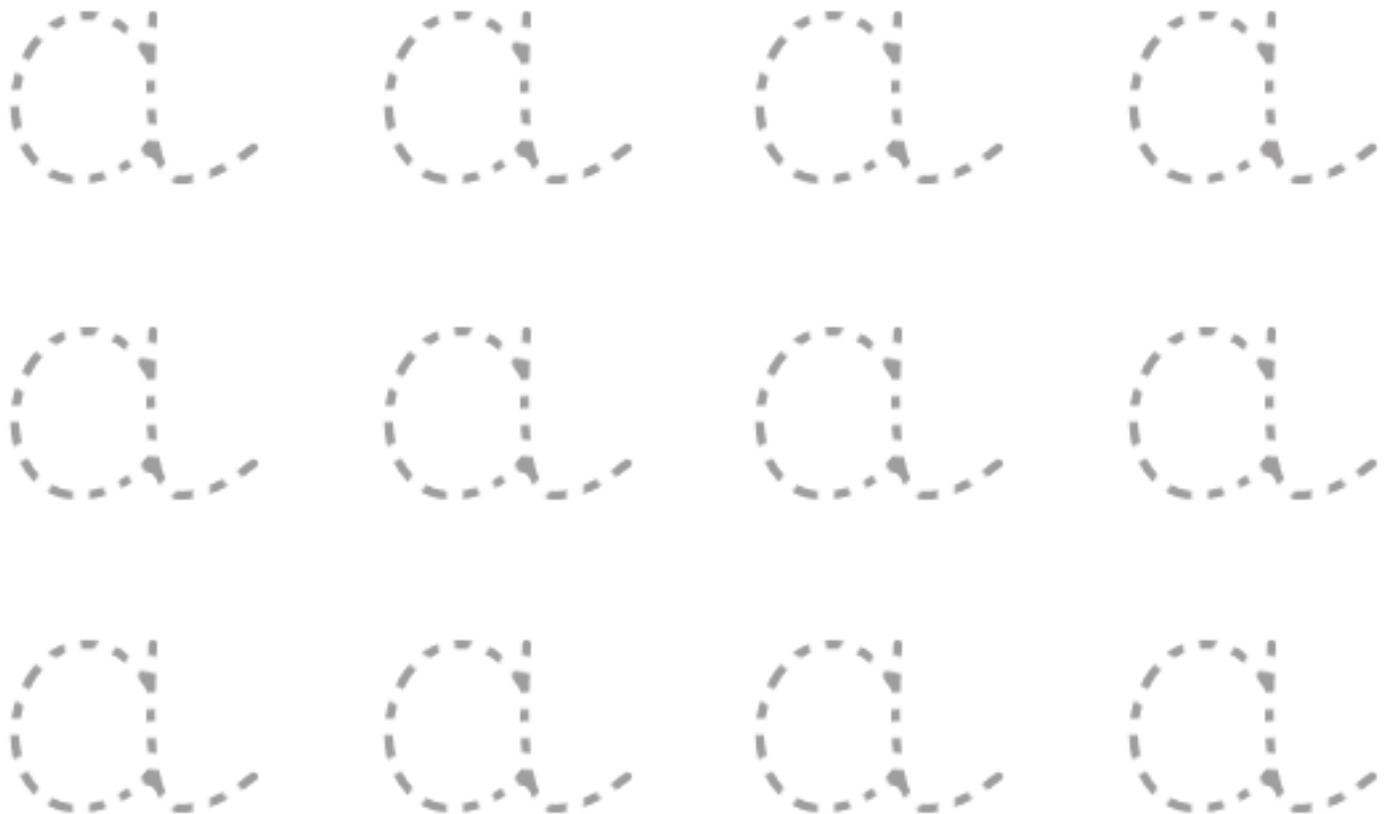

Nombre: ..... Fecha: ..... Curso: .....

# Letra A



Rodea con un círculo las palabras que **empiezan por 'a'** y colorea la letra:



[www.edufichas.com](http://www.edufichas.com)



# Letra A

edufichas.com



ardilla

Completa con la letra 'a'...

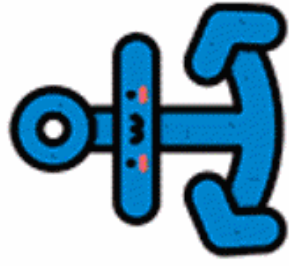

...ncl....

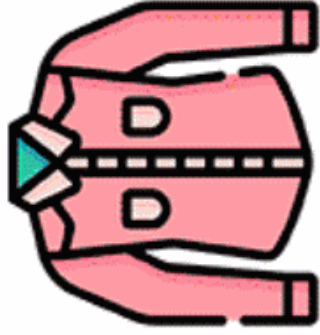

c...mis....



l...n....

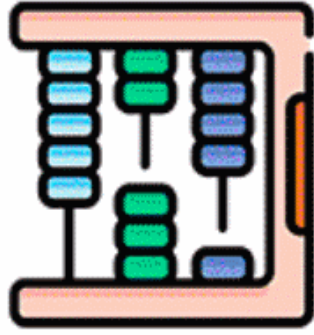

b...co

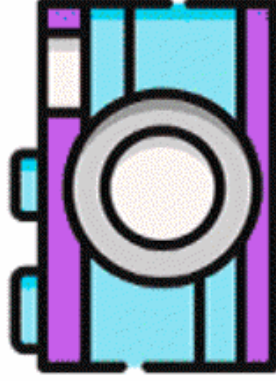

c...m...r....



c...s....

Nombre: ..... Fecha: ..... Curso: .....

# Letra A

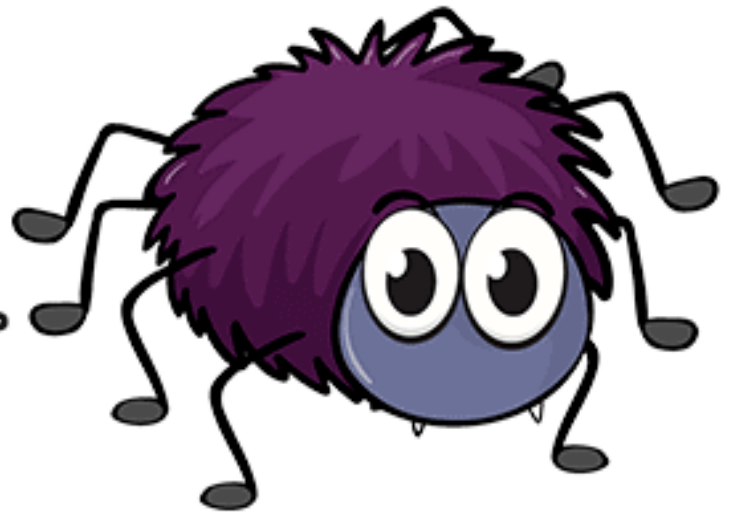
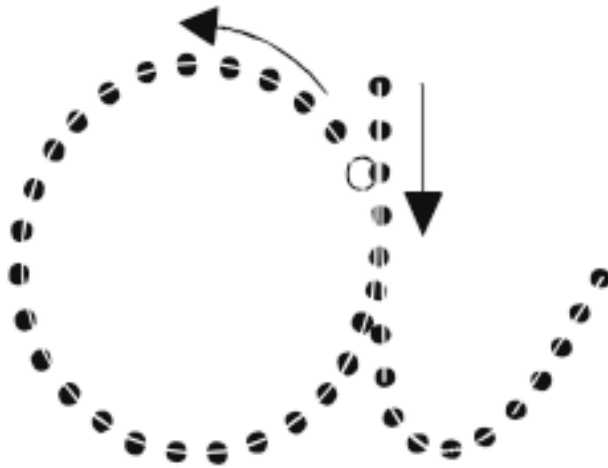

[www.edufichas.com](http://www.edufichas.com)

araña

a a a a a a a a a

a a a a a a a a a

a a a a a a a a a

a a a a a a a a a

Colorea la letra 'a'...

O e a i  
e a i  
y a i

[edufichas.com](http://edufichas.com)

e e A

O O i a O  
y



Colorea la letra 'a'...

a	u	e	u	a	e	a	o	a	u	i	o
e	i	i	e	u	a	e	i	e	a	e	a
u	e	o	u	o	u	i	u	u	a	e	a
i	a	i	o	a	i	u	a	e	e	e	a
e	o	a	e	o	e	i	e	a	u	u	u
a	u	i	a	i	o	a	i	a	u	a	u

www.edufichas.com



Nombre: ..... Fecha: ..... Curso: .....

# Letra A



www.edufichas.com



Completa con la letra 'a'...



b...llen... c...b...ñ... c...r...col

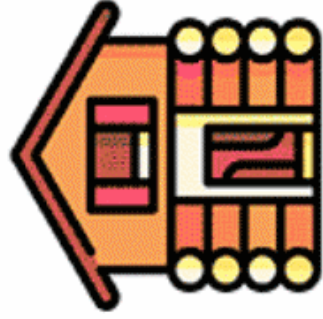

c...b...ñ... c...r...col



c...b...ñ... c...r...col



b...n...n...s...c...b...llo

edufichas.com



c...b...llo



g...f...s

Colorea la letra 'a'...

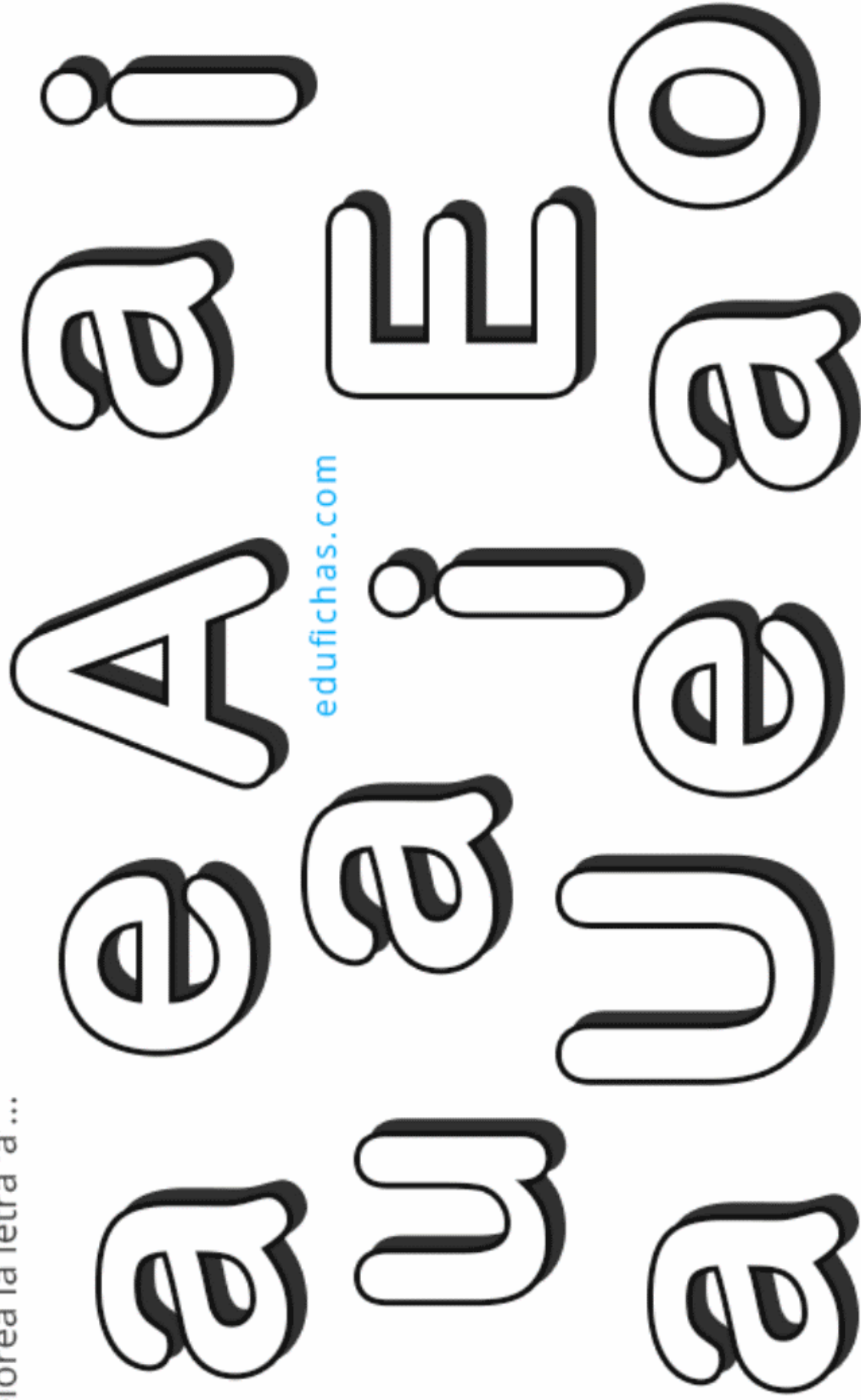

1. Traza y colorea la letra "A"

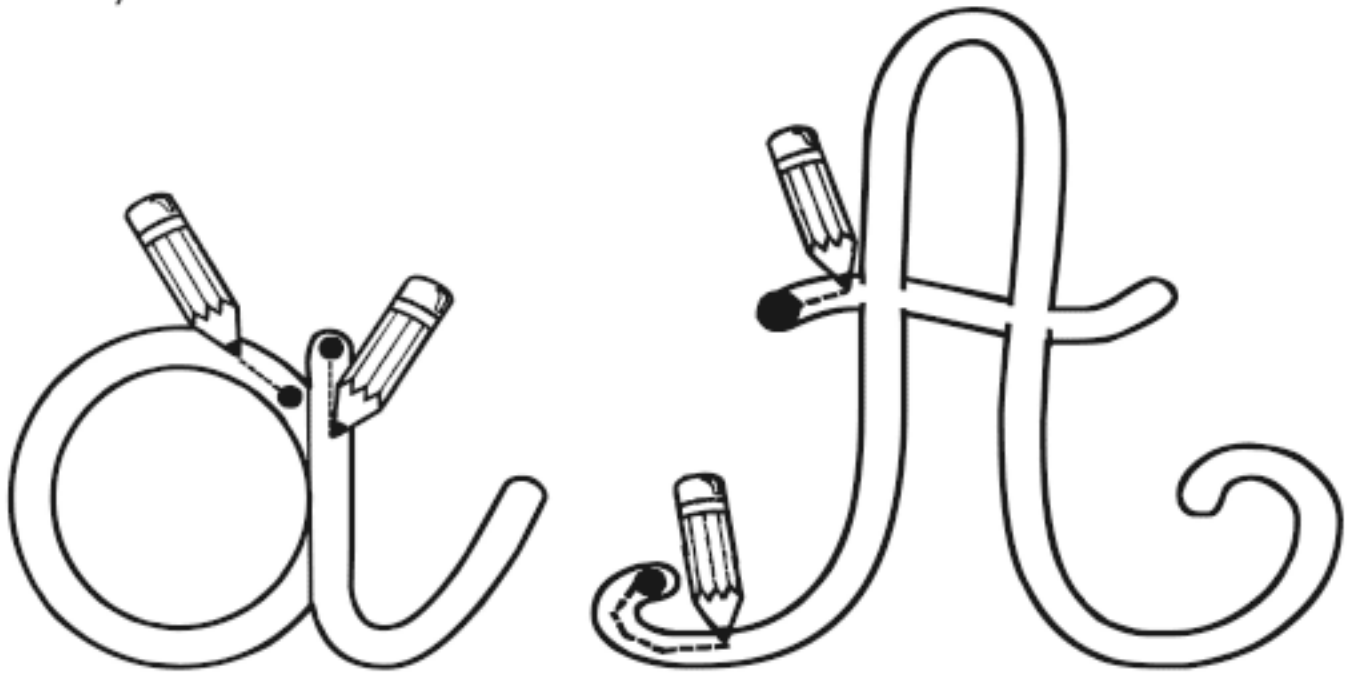

2. Escribe la letra "A"

Tracing practice lines for the letter 'A' on a three-line grid. The first row contains eight dashed circles. The second row contains five dashed circles. The third row contains seven dashed uppercase 'A's. The fourth row contains three dashed uppercase 'A's.

# Descarga los cuadernos de actividades de las otras vocales:





Si te ha gustado, puedes pasarte por nuestra web en busca de más actividades. Fichas, cuadernos y recursos educativos gratis:

<https://www.edufichas.com/>